

TOP MOUNT INSTALLATION BRACKETS

FOR OUTSIDE MOUNT:

- Mount brackets to the wall or window frame, using screws through back of bracket. (Fig. 20) (For ceiling mount, see "Inside Mount" on other side.)
- Make sure to mount brackets so that the blind will be **level** for proper operation.
- **IMPORTANT!** Top mount brackets must be located where they will not interfere with blind components when headrail is installed.

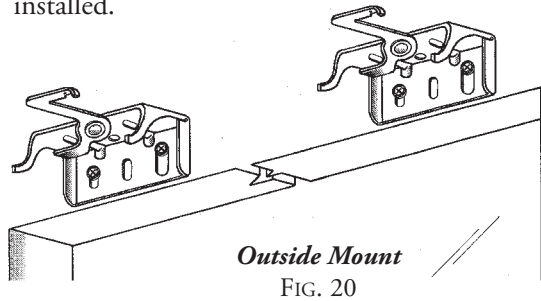

INSERT HEADRAIL INTO BRACKET

- Tilt and slip the inside lip of the headrail into the cam bracket hooks. (See Fig. 21A)
- Raise the back of the headrail so that it is snug against the top of the bracket. (See Fig. 21B)
- Rotate the lock arms on the brackets until they snap into the locked position securing the headrail. (See Fig. 21C)

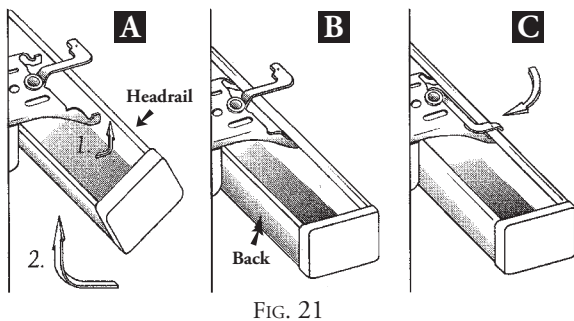

TO OPERATE YOUR BLIND

Your blind is equipped with an automatic locking mechanism that holds the blind at the desired height when the lift cords hang down vertically.

- To raise or lower the blind, pull and angle the lift cords toward the middle of the blind. (Fig. 22) A slight tug will release the cord lock allowing the blind to be moved up or down.
- At the desired height, return the cord to the vertical position to re-engage the cordlock. (Fig. 23)
- When raising or lowering the blind, the slats should be horizontal (open).

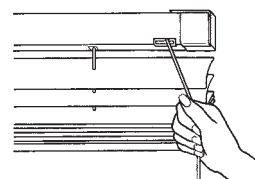
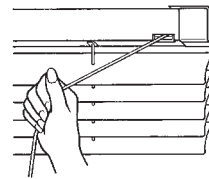

CARE AND CLEANING

Occasional dusting or vacuuming with a brush attachment is all that is necessary to keep your blind looking new.

CHILD SAFETY

To help protect children and pets from becoming tangled in lift cords, your blind comes with a two-piece cord stop which breaks in two when pressure is applied. Simply snap the two halves back together.

An important consideration in any blind installation is child safety. To prevent serious injuries or strangulation, all cords must be kept out of the reach of children. Cord cleats or another method of keeping the lift cords from hanging within reach of a child should be utilized.

METAL BLIND INSTALLATION INSTRUCTIONS



HOW TO INSTALL YOUR METAL BLIND

Please take a few minutes to read these instructions. When properly installed, your Roulett Blind will provide many years of beauty and dependable service.

HARDWARE INCLUDED

- | | |
|---|--------------------------------------|
| ■ Installation Brackets
(type varies depending on style of headrail) | ■ Optional Hardware:
(If ordered) |
| ■ Mounting Screws | • Extension Brackets |
| ■ Support Brackets
(For larger blinds) | • Spacer Blocks |
| ■ Valance Clips | • Hold-down Brackets |

TOOLS NEEDED

- | | | |
|----------------|--------------|---------|
| ■ Pencil | ■ Drill | ■ Level |
| ■ Screw Driver | ■ Drill Bits | |

FASTENERS FOR OTHER SURFACES

(NOT INCLUDED)

The screws provided are for mounting the blind to a wood surface only. For other surfaces, use the following:

- **Wallboard or Plastic** - Pre-drill holes for suitable hollow wall anchors or toggle bolts.
- **Metal Surfaces** - Pre-drill holes and use short metal screws.
- **For Concrete, Stone, Brick or Tile** - Use a carbide drill and appropriate plugs, or anchor with screws.

BEFORE MOUNTING THE BLIND

- Hold the blind (with brackets on the ends) against the window opening to determine that it fits inside or outside the opening. (See Figs. 1 and 2.)

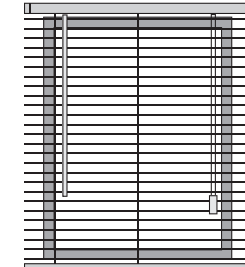
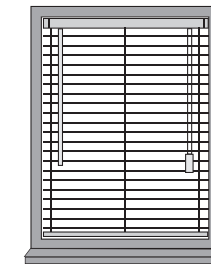

Inside Mount

FIG. 1

Outside Mount

FIG. 2

- If blind is for inside mount installation, and if the window frame is **not** even or level (Fig. 3), use shims to make sure that the headrail **will** be level when installed. (See Fig. 4)

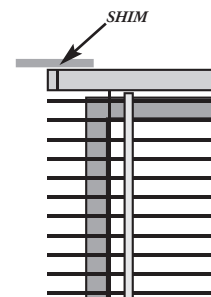
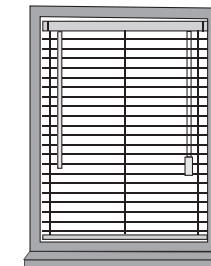

Uneven Frame

FIG. 3

Shim as necessary

FIG. 4

- If the headrail is outside mounted on the frame, wall or ceiling, it **must** be level, so that the blind will operate properly.
- Also make sure that the blind is the proper length and that it will clear any obstructions. (Spacer blocks or extension brackets may need to be installed, so that blind clears any obstructions.)

Continued other side ▶

MOUNT INSTALLATION BRACKETS

Two hinged-cover installation brackets have been provided with your blind, a left hand and right hand, marked "L" and "R". (See Fig. 5) The covers, when closed, will secure the blind firmly in place.

Open the bracket covers to expose the screw holes. The brackets are designed to be mounted with two diagonally located screws.

FOR INSIDE MOUNT:

- Mount brackets to the jamb (Fig. 6) or to the soffit (Fig. 7) of the window frame.

FOR OUTSIDE MOUNT:

- Mount brackets to the window frame (Fig. 8) or to the ceiling. (Fig. 7)

INSTALL THE BRACKETS

- Hold the blind (with brackets on the ends) against the mounting surface of the window opening. (Make sure blind remains level.)
- Mark on the surface the position of the brackets.
- Remove the blind and place the brackets alone on the marks, then mark the screw hole positions on the mounting surface.
- Drill pilot holes for the screws into the surface. (Holes must be drilled through shims as well if they are used.)
- Mount the brackets with screws provided.

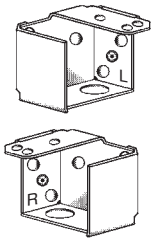

Mounting Brackets
FIG. 5

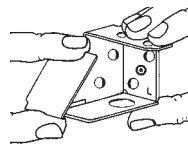

Opening Brackets

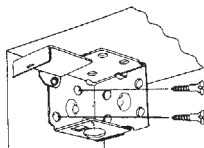

Jamb Mount
FIG. 6

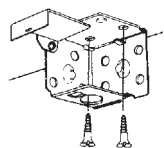

Soffit or Ceiling Mount
FIG. 7

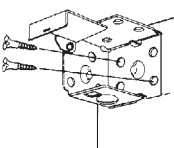

Window Frame or Wall Mount
FIG. 8

EXTENSION BRACKETS / SPACER BLOCKS

If **Extension Brackets** (Fig. 9) were ordered, they must be attached to the mounting surface **first**. Then bolt the installation brackets to the extension. (See Fig. 9) Note: Center support brackets for larger blinds will also need to be attached using extensions.

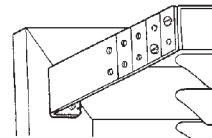

Extension Bracket with Installation Bracket

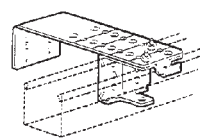

Extension Bracket with Center Support Bracket

FIG. 9

If **Spacer Blocks** (Fig. 10) are used, attach the installation brackets to the mounting surface through the spacer blocks.

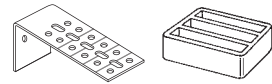

Use Extension Bracket and Spacer Block to clear obstructions
FIG. 10

SUPPORTING WIDE BLINDS

Blinds wider than 48" require **Center Support Brackets**. Blinds over 72" wide will require 2 support brackets. Do not space support brackets more than 48" apart. Do not position support brackets where they will interfere with the lift cords and braided ladders.

(On three-ladder blinds, install support bracket two inches to the left or right of center.)

- Align support brackets with the installation brackets. (See Fig. 11). Mark screw holes on mounting surface. Drill pilot holes for screws and attach the support brackets. (Note: For inside and ceiling mounts, the fronts of the brackets must line up.)

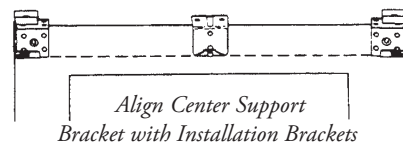

FIG. 11

INSTALL HEADRAIL INTO BRACKETS

- Snap the **Valance Clips** onto the headrail **before** inserting it into the brackets. Each blind requires the same number of clips as there are braided ladders. Do not position clips where they will interfere with headrail componentry. (Fig. 12)

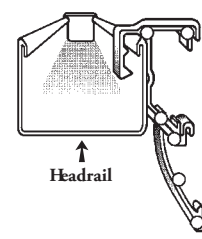
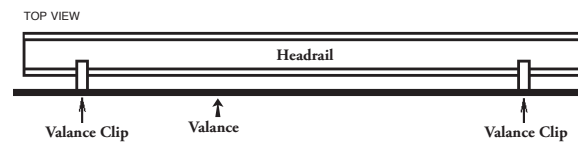

FIG. 12



- Slide the headrail into the brackets. (Fig. 13)

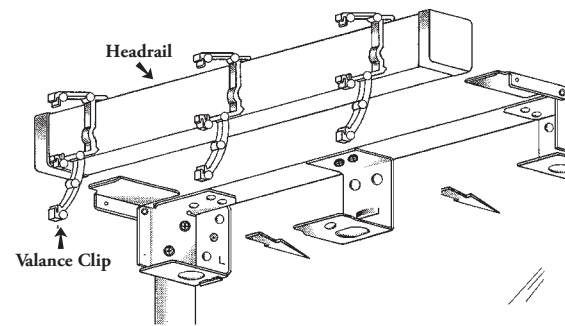

FIG. 13

- Close the hinged covers on the installation brackets. (Make sure the covers are **locked** so that the blind is secure.) (Fig. 14)

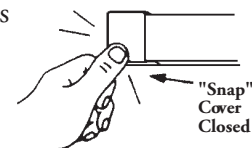
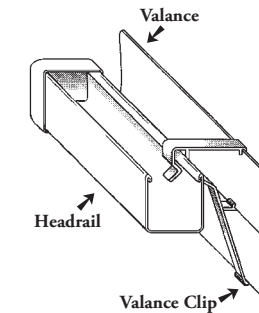

FIG. 14

ATTACH THE VALANCE

A 2-slat valance is included on orders with blinds installed using the hinged cover installation brackets. A valance is not included on blinds installed with the top mounted installation brackets. (see Fig. 15)



2-Slat Clip-on Style Valance
FIG. 15

BOTTOM RAIL HOLD DOWN BRACKETS

- Lower blind to desired length and fit the **Hold Down Brackets** into the bottomrail endcap pins.
- Mark the hole positions on the mounting surface. (window sill, frame, or door)
- Mount the hold down brackets with screws.

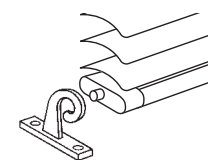

Sill Mount

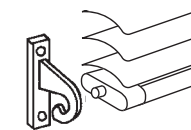

Door Mount
FIG. 17

INSTALLING BLINDS USING TOP MOUNT INSTALLATION BRACKETS

Top Mount Installation Brackets are used on blinds with the 1 1/2" x 1" headrail. If you were sent this style of installation bracket, please follow this section for proper bracket and blind installation.

MOUNT TOP MOUNT INSTALLATION BRACKETS

- Rotate the arm on each bracket to the open position. (See Fig. 18)

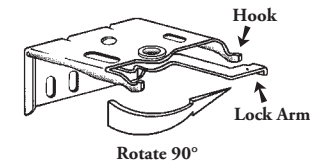
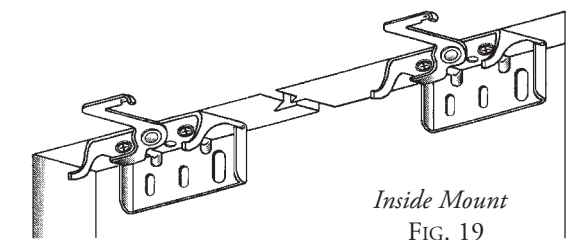

FIG. 18

FOR INSIDE MOUNT:

Mount brackets to the soffit (inside top) of the window frame. Secure with screws through top of bracket. (See Fig. 19)

- If window frame is not level, use shims to level the blind for proper operation. (See other side)
- IMPORTANT!** Cam brackets must be located where they will not interfere with blind components when headrail is installed.



Inside Mount
FIG. 19